



*Building a future
in which people live in harmony
with nature.*

TOGETHER



*Available on iPad, Android and Kindle Fire tablets
worldwildlife.org/together*

How to fold an origami

G O R I L L A



*Origami design by Joseph Wu / Diagram by Andrew Hudson
©2012 World Wildlife Fund*



1. Start with a square piece of paper.

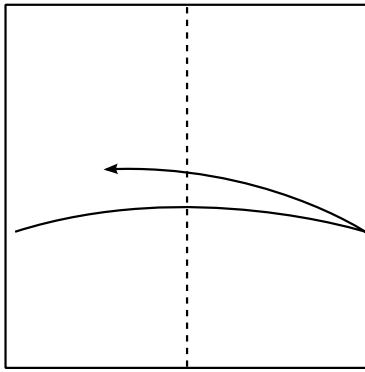

2. Fold and unfold.

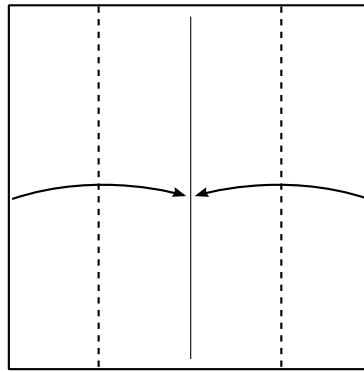

3. Fold the edges to the center.

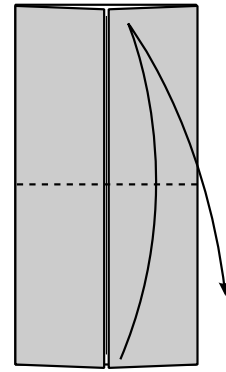

4. Fold and unfold.

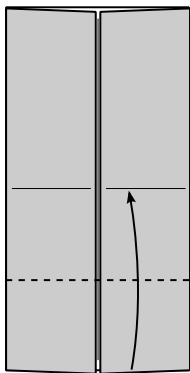

5. Fold to the center.

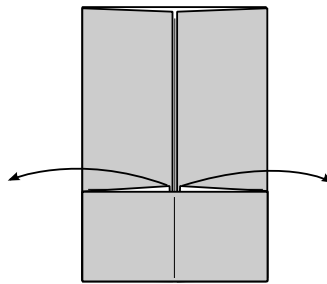

6. Pull out corners and squash.

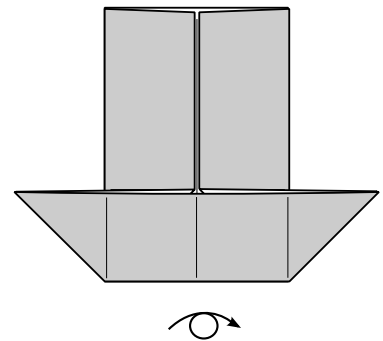

7. Turn over.

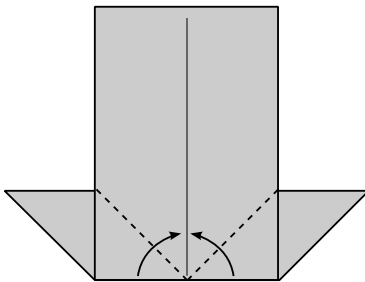

8. Bisect angle.

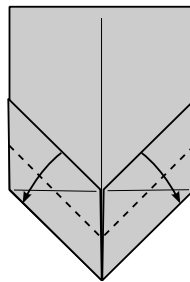

9. Match up edges.

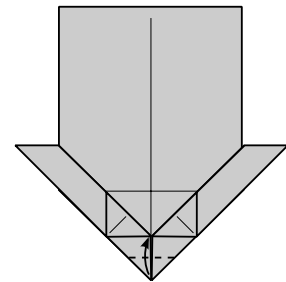

10. Fold.

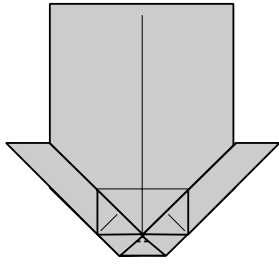

11. Fold down about 1/3.

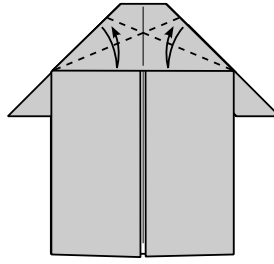

12. Crease angle bisector.

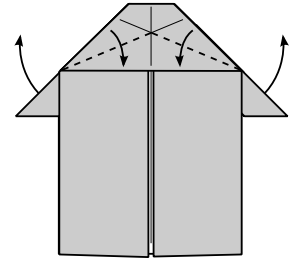

13. Fold both at once, allowing the arms to swing out from behind.

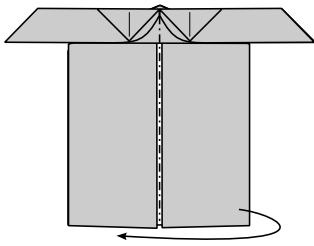

14. Fold the whole model in half.

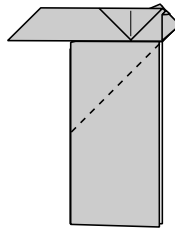

15. Bisect angle.

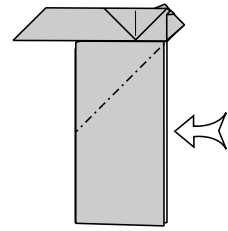

16. Reverse fold.

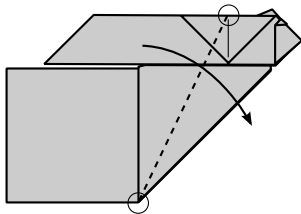

17. Fold through endpoints. Repeat behind.

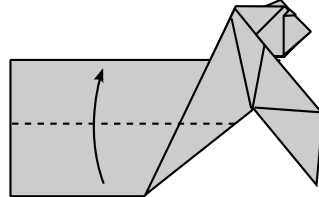

18. Fold to spine. Repeat behind.

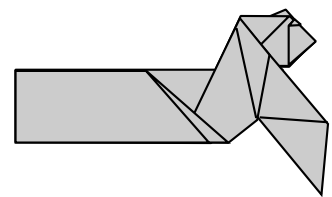

19. Open the back half of the model along the spine.

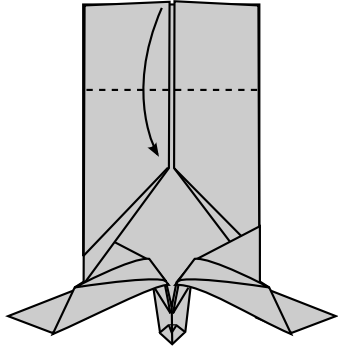

20. Fold down.

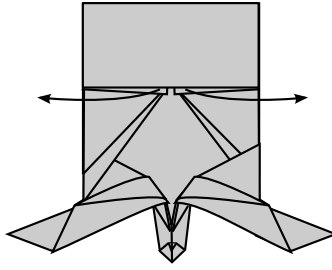

21. Pull points out.

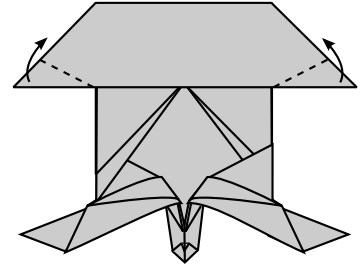

22. Fold feet at an angle.

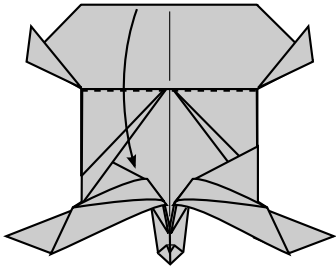

23. Fold legs down.

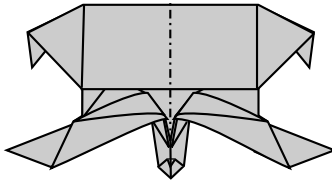

24. Fold the model flat again.

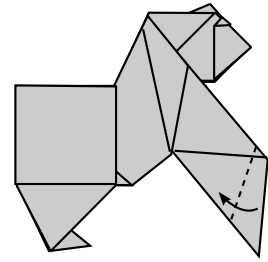

25. Fold the hands so that they are on the same line as the feet.

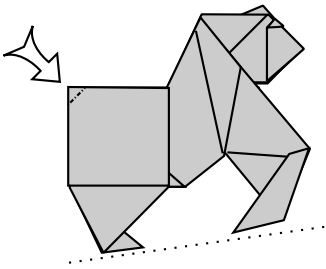

26. Round the rear of the gorilla.

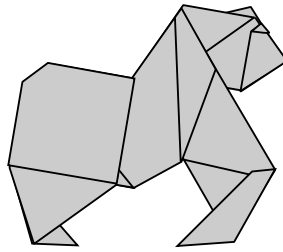

27. Finished!
